

INNOVA

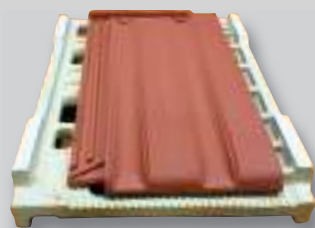



CERAMIC ROOF SOLUTIONS



Single H fire supports that allow the tiles to be fired individually at high temperatures, obtaining perfect definition.



PERFECTION IS TO REACH THE TOP. La Escandella stands once again by the latest technology, heavily investing in a new production line designed to optimize the finish of its products and creating a Premium product range. [Discover the new H-Selection line, made for excellence.](#)

H-Selection is the result of applying modern manufacturing processes in H-Cassette to a selection of our products, endowing them with numerous functional and aesthetic advantages and benefits.



Excellent flatness

Individual curing of each tile thanks to support in H. Excellent flatness with no contact points.



High definition on each piece

It provides a perfect definition on each piece, made with gypsum moulds, providing a much finer texture.



Low absorption

Higher resistance to ice and mould formation.



Lifetime warranty

Our 100 years of warranty ensure your peace of mind and demonstrate the quality of our manufacturing process.

INNOVA

Ample longitudinal overlapping (80mm)

Avoids cutting the tiles, therefore reducing time and installation costs.

Higher resistance

The clay composition together with the perfect pressing allows flexion higher than the required while only weighing 3,4 kg.

Lower absorption (<5%)

High quality clay together with high firing temperature mean higher resistance to ice and mildew.

High definition on each piece

The gypsum moulds provides a perfect finish, obtaining a smoother texture, no contact points nor creases.

Double interlocking

The double interlocking -horizontal and vertical- allows the roof to be more watertight, ensuring its impermeability.

Excellent flatness

H-Cassette manufacturing provides a perfect finish to each product.

Cost reduction

Its large format (11.5units/m²) and strapping every 6 units, as well as its packaging on pallets of 216 and 288 units, reduce installation costs



TECHNICAL CHARACTERISTICS

Flexural Strength test (EN 538)	Resistance > 1200N
Water Impermeability (EN 539-1)	Complies with level 1
Frost Resistance (EN 539-2)	Complies 150 cycles
Geometric Characteristics (EN 1024)	Flatness / Straightness ≤ 1,5%

Dimensions*	L: 465mm; W: 258mm; H: 30mm L: 18.3"; W: 10.16"; H: 1.18"
Pieces /m ² /sq.	11.5 / 105
Weight piece	3.4 kg / 7.5 lbs
Longitudinal fit **	396mm (+5mm/-75mm) / 15.6" (+0.19"; -2.95")
Transversal fit **	214mm (± 1mm) / 8.42" (±0.04")
Units per pallet	216 / 288
Laying	Straight / broken bond

*The tile dimensions indicated in this chart allow a tolerance of approximately +/-2%
**Theoretic value: this should be re-calculated on site with the tiles that are to be used.



According to European standard



Test of frost resistance



Impermeability



Flexural strength test



Geometric characteristics



La Escandella
100 YEARS
GUARANTEE

PERFECTION AT THE
FOREFRONT OF DESIGN

200 SANTA BARBARA PARADE

FINISHES



TNPK
SLATE KLINKER



Inspiring Colours



TNMK

BROWN KLINKER



TNRK

RED KLINKER



TNRRK

RUSTIC RED KLINKER



TNCEK

PEPPER KLINKER



TNYK

GALAXY KLINKER

TECHNICAL ADVANTAGES

1 LOWER ABSORPTION AND HIGHER FROST RESISTANCE

- Water absorption on Klinker H-Cassette tiles is lower than 5%.
- Higher resistance to ice and mildew.

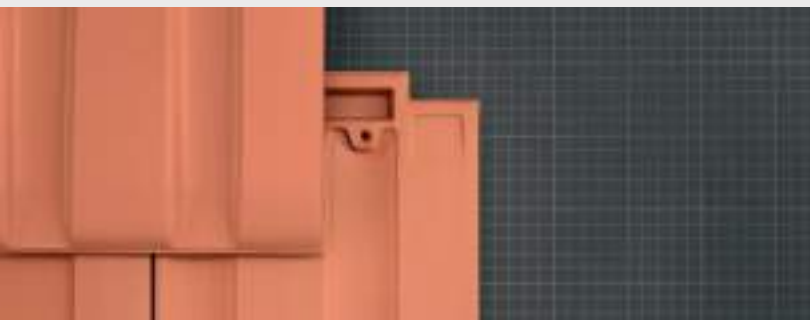

2 OVERLAPPING

- 80mm of longitudinal fit (between 11,5 and 15 pieces per sqm).
- Adaptable for re-roofing on already laid battens (reburishments)



3 INTERLOCKING

- 45mm interlocking > Large drainage rib.
- *Bigger watertightness.*



4 TOP INTERLOCKING

- Top interlocking sealed.
- *Bigger wattertightness: tiles can be fixed straight on due to the interlocking system.*



5 NAIL HOLE

- Pre-hole (easy to be nailed)
- *Less tile breakages when nailing.*

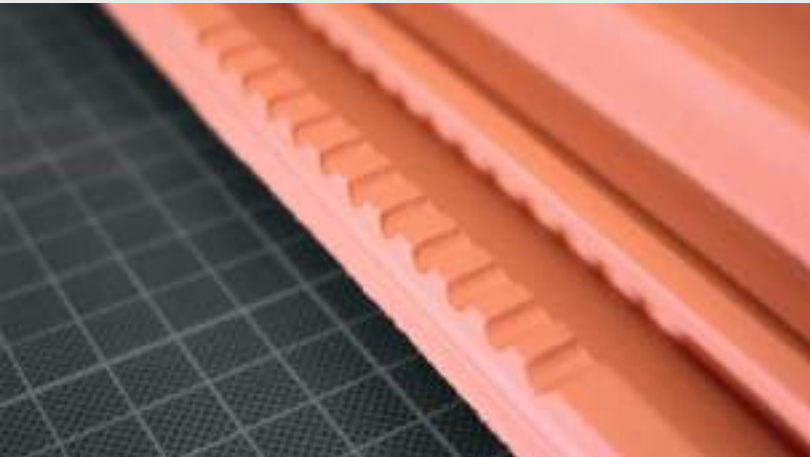

6 HOOK ATTACHMENT

- Sawtooth.
- *Easy hook fixing; one hook allows to fix 3 roof tiles at same time*

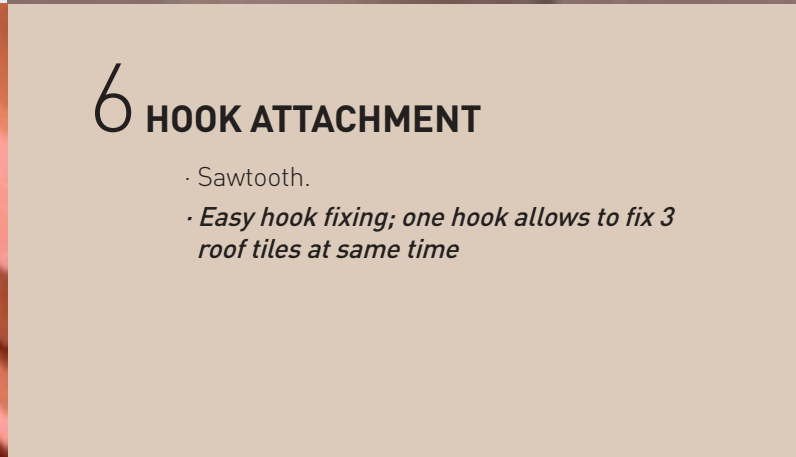

A close-up photograph of a car's interior dashboard. The image shows a dark grey or black textured surface with a prominent red trim strip curving across the frame. A thin orange horizontal line is visible near the top of the image. The text is overlaid on a semi-transparent orange rectangular area at the bottom.

BEAUTY & FUNCIONALITY
ALL IN ONE

LAI D METHOD

First course batten should be 20mm [0.78"] higher than all succeeding course battens to provide a vertical alignment and to assure a symetrical installation.

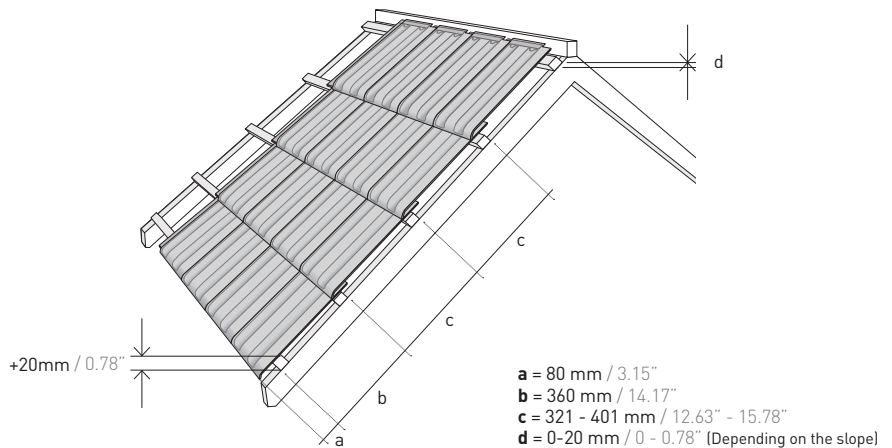

STRAIGHT BOND

1. The starter course will begin with the Q116*K right side course, continuing with the full tiles to complete the eave. The tiles structuring the eave will have to overlap the side course and fit together one to another. We will finish the eave with the Q115*K left side course.
2. The second course will be started again installing the Q116*K right side course and doing the same as in step 1.
3. This exposure is continued through each successive course till the ridge.

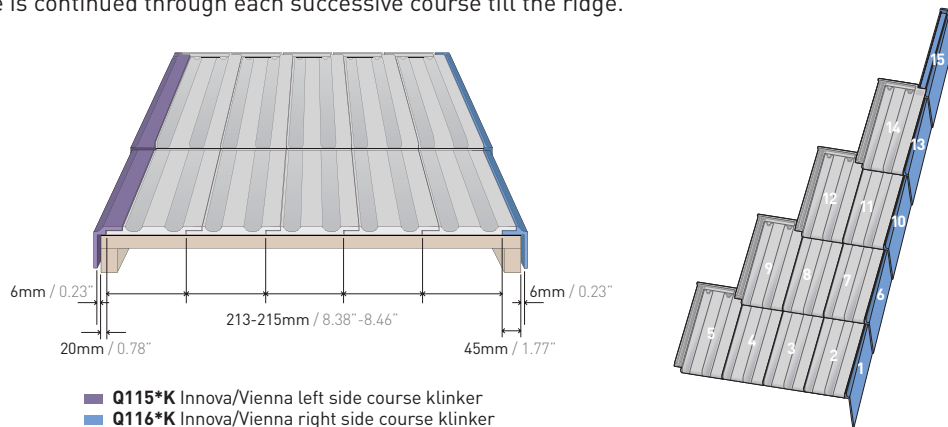

BROKEN BOND

1. The starter course will begin with the Q116*K Right side course, continuing with the full tiles to complete the eave. The tiles structuring the eave will have to overlap the side course and fit together one to another. We will finish the eave with the Q115*K Left side course.
2. The second course will be started again with the Q116*K Right side course, continuing with Half tile Q119*K and will be laid to provide the proper vertical exposure. This exposure is continued through each successive course.
3. All joints of the second course and succeeding courses should be at the center line of the previous course, alternating half tiles (Q119K) and full tiles at the start and at the end of each course.

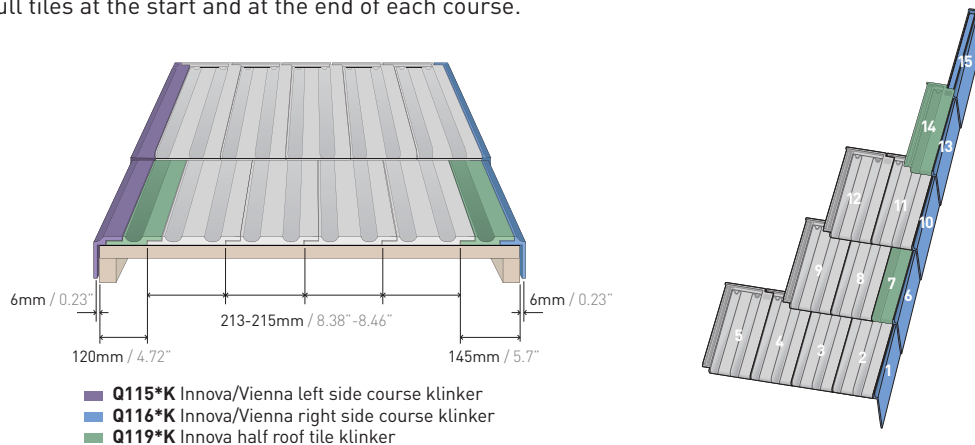

INSTALLATION DETAILS

RIDGE

- Ridge tiles must be installed lap facing away from the prevailing winds, in order to assure water tightness.
- Field tiles at top course should be secured directly either into the deck or top batten with stainless ring screw nails or similar.
- All ridges and hips shall be covered with self adhesive Alu-Roll (La Escandella Aluminum roll for hip and ridges - CAM01) or similar approved breathable waterproof underlayment. Underlayment should be secured over the ridge nailed with non-corrosive roofing nails.
- Apply ridge tiles with a minimum overlapping of 5 cm (2") throughout the ridge line facing away from the prevailing wind-driven rain.

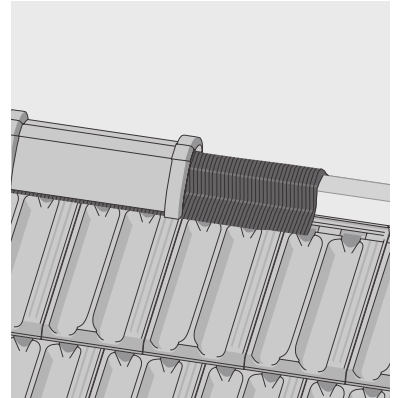

HIP

- Hip tiles must be installed in the same way as in the ridge.
- Field tiles must be miter cut parallel to the hip line and secured.
- All ridges and hips shall be covered with self adhesive Alu-Roll (La Escandella Aluminum roll for hip and ridges - CAM01) or similar approved breathable waterproof underlayment.
- Air should be able to flow through the ridge and hip area. Be sure not to close these off with mortar or similar. Closing them off could result in cracks, peeling off., in freezing and thawing cycles.

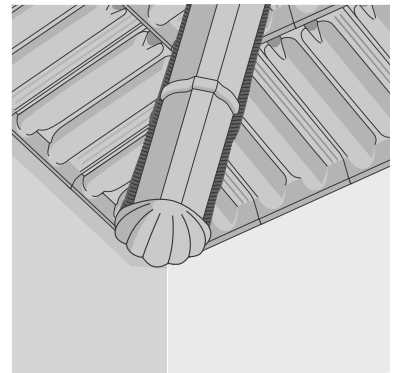

VALLEY

- Both Valley and eave line channel are particularly vulnerable to water migration and leakage. Valleys should have a clear and unobstructed pathway for quick water drainage.
- Install valley battens on each side of the valley crease. Alu-roll Valley (CAM18), or similar approved adhered waterproof valley underlayment, shall be laid vertically up all valleys in addition to other required underlayment that should be fixed by using glue, resin or similar.
- Where valley intersects with ridge line, apply Alu-roll Valley (CAM18), or similar approved underlayment, which should be covered by the ridge tile. Valley should be extended along the eaves to overhang the fascia board by 5cm (2") or over the gutter.
- Tiles should be laid parallel to the valley line, at same relative angle and should overhang the valley battens by at least 10 cm (4").
- Tiles at each side of the valley crease should be laid to provide a minimum 15 cm (6") width gap (tiles should held back minimum 7.5 cm (3") from the center of the valley each way).
- Valley tiles must be secured.
- Proper Valley flashing installation is required to ensure water tightness in order to avoid cracks, peeling off,...**

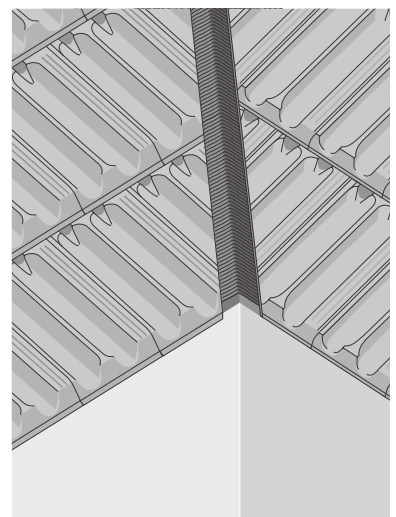

ACCESSORIES

Q01*K | Ridge / Hip klinker



2,600 gr / 5.73 lbs 3 u./lm

Q02*K | Round ridge / Hip klinker



3,400 gr / 7.49 lbs 2.5 u./lm

Q90*K | Atica ridge 120° klinker

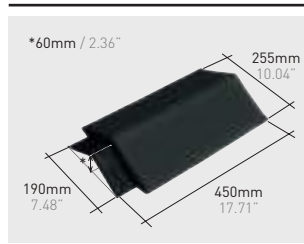

3,600 gr / 7.93 lbs 2.5 u./lm

Q120*K | Angular ridge klinker



3,600 gr / 7.93 lbs 2.5 u./lm

Q03*K | Ridge end / Hip starter klinker



2,900 gr / 6.39 lbs with **Q01*K**

Q04*K | Round ridge end / Hip starter klinker



3,600 gr / 7.93 lbs with **Q02*K**

Q109*K | Atica 120° hip / end ridge klinker



2,900 gr / 6.39 lbs with **Q90*K**

Q122*K | Angular hip / end ridge klinker



3,300 gr / 7.27 lbs with **Q120*K**

Q05*K | End cap / Straight gable end klinker



2,100 gr / 4.63 lbs with **Q01*K**

Q83*K | End cap round ridge klinker



2,600 gr / 5.73 lbs with **Q02*K**

Q110*K | Atica collar ridge klinker

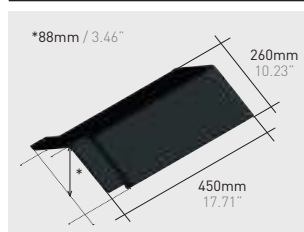

3,500 gr / 7.71 lbs 2.5 u./lm

Q124*K | Angular end cap klinker

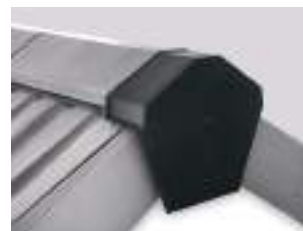
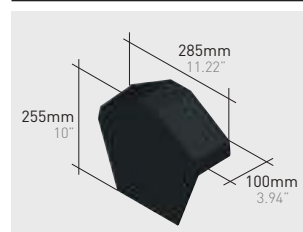

2,180 gr / 4.8 lbs with **Q120*K**

Q55*K | Round 3 way ridge female klinker



4,100 gr / 9.04 lbs with **Q02*K**

Q44*K | Round 3 way ridge klinker

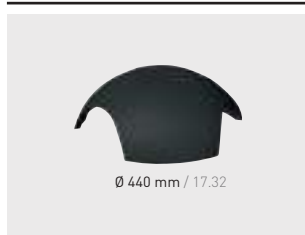

4,600 gr / 10.14 lbs with **Q02*K**

Q45*K | Round 4 way ridge klinker



4,100 gr / 9.04 lbs with **Q02*K**

Q111*K | Atica 120° 3 way ridge klinker

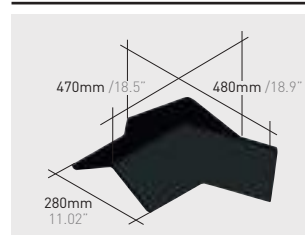

5,100 gr / 11.24 lbs with **Q90*K**

Q123*K | Angular 3 way ridge klinker

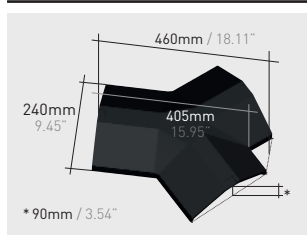

3,720 gr / 8.2 lbs with **Q120*K**

Q115*K | Innova/Vienna left side course klinker

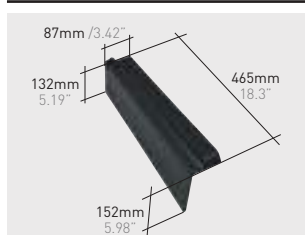

2,750 gr / 6.06 lbs 2.5 u./lm

Q116*K | Innova/Vienna right side course klinker



2,400 gr / 5.29 lbs 2.5 u./lm

Q119*K | Innova half roof tile klinker



2,000 gr / 4.4 lbs

Q117*K | Innova/Vienna ventilation roof tile klinker



3,550 gr / 7.82 lbs

Q118*K | Innova/Vienna chimney roof tile klinker



3,550 gr / 7.82 lbs

Q121*K | Innova-Vienna Chimney klinker



2,500 gr / 5.51 lbs with **Q118*K**

ROOFING COMPONENTS

La Escandella offers a wide range of non-ceramic accessories which help finish off any type of roof. From waterproofing to ventilation, fixing and batten installing, safety implementation and multiple profiles can be found here. (Ask for wider range in last Price List).

CAM01 / CAMF1
Alu-Roll With Micro Cut

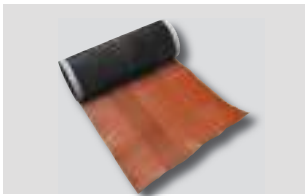

Width: Several sizes
Colours: Red, paja, brown, black.

CAM08 / CAMF8
Alu-Flex



Width: Several sizes
Colours: Red, paja, brown, black.

CAM09 / CAMF9
Alu-Roll Membrane



Width: Several sizes
Colours: Red, brown, black.

CAM18
Alu-Valley Tape



Width: 50 mm / 1.96"
Colours: Red, black, brown.

CAM65 / CAM21 / CAM52 / CAM53
Waterproof membrane



Dimensions: 1,5 m x 50 m / 1.64 yd x 54.68 yd
Weight: several weights.

CAM27 / CAM70 / CAM07 / CAM10
Ridge Tile Hook



Colours: Red, brown, black.

CAM05 / CAM010 / CAM51
Ridge Batten Bracket



Dimensions: Several sizes.

CAM14
Eaves Ventilation Comb



Dimensions: 6cm x 1m / 2.36" x 39.37"
Colours: Red, black.

CAM64
Metal clip clipped with a bumper



CAM59
Metal clip for wood battens

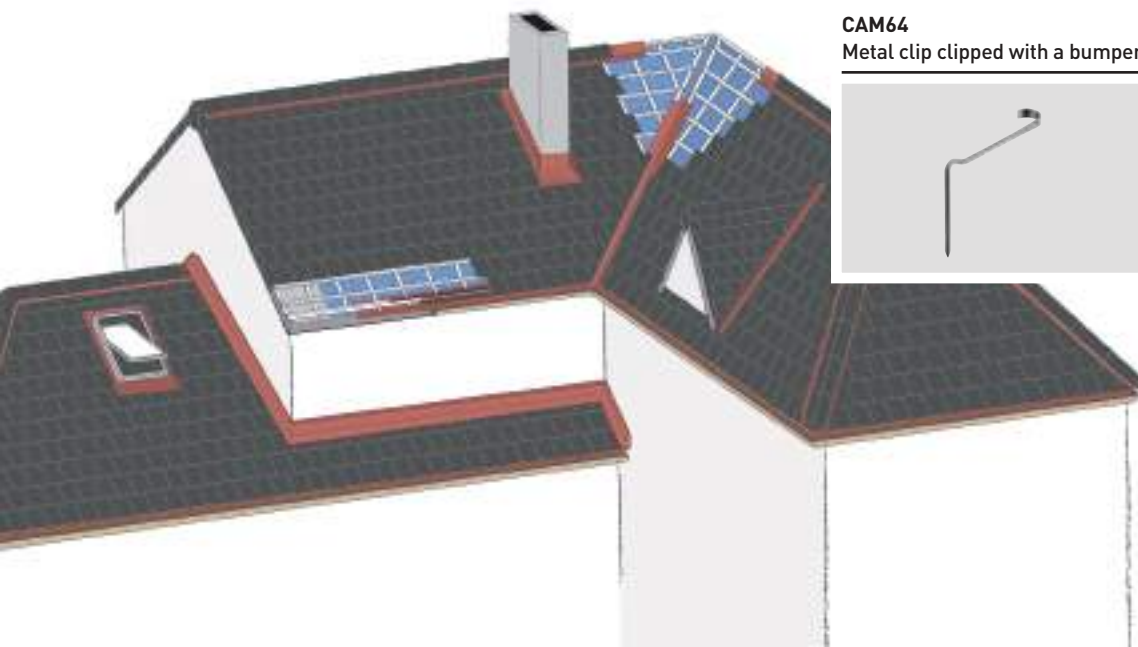
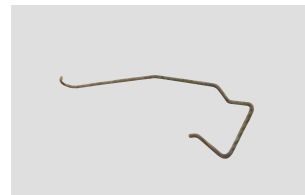

TECHNICAL INFORMATION

SLOPES / PITCHES

The minimum pitch standard recommendations should always be followed (see values in the referral table). On all pitches below the standard recommended minimums, or in regions where ice dams may occur, a waterproof underlayment on the entire deck **MUST** be applied. Most problems with water-shedding roof installations occur from water that migrates through the joints of the tiles through capillarity action, wind-driven rain, and runoff or ice damming. Because of this possibility, the underlayment is critical to the success of the roof.

	WITHOUT UNDERLAYMENT				WITH UNDERLAYMENT			
	ZONE 1	ZONE 2	ZONE 3		ZONE 1	ZONE 2	ZONE 3	
Protected	25% / 14°	27% / 15,5°	30% / 17°	Hip < 6,5 m	19% / 10°	21% / 11°	23% / 12°	Protected
Normal	25% / 14°	27% / 15,5°	30% / 17°		21% / 11°	23% / 12°	26% / 14°	Normal
Exposed	33% / 18,5°	37% / 20,5°	40% / 22°		28% / 15°	32% / 17°	34% / 18,8°	Exposed
Protected	28% / 16°	32% / 18°	36% / 20°	Hip 6,5 m - 9,5 m	22% / 12°	24% / 13°	26% / 14°	Protected
Normal	28% / 16°	32% / 18°	36% / 20°		24% / 13°	27% / 15°	31% / 17,5°	Normal
Exposed	35% / 19,5°	39% / 21,5°	43% / 23,5°		30% / 17°	33% / 18°	42% / 22°	Exposed
Protected	32% / 18°	35% / 19,5°	40% / 22°	Hip 9,5 m - 12 m	23% / 12°	26% / 14°	30% / 17°	Protected
Normal	32% / 18°	35% / 19,5°	40% / 22°		27% / 15°	30% / 17°	34% / 18,8°	Normal
Exposed	42% / 23°	45% / 24,5°	50% / 26,5°		36% / 19°	39% / 21°	43% / 23,5°	Exposed

Note: For hips MORE than 12m long (39.4'), a waterproof underlayment on the entire roof deck **MUST** be applied and the ventilation underneath must be reinforced (check with the manufacturer).

PROTECTED LOCATIONS: hollow area which is surrounded by hills that protect the hollow from the winds in all directions..

NORMAL LOCATIONS: Flat area, plateau with minimal elevation changes.

EXPOSED LOCATIONS: Places open to strong winds, coastal areas (up to 5 km / 3 miles from the shoreline), islands or narrow peninsulas, estuaries or closed bays, narrow valleys, isolated mountains, mountain passes and earthquake zones.

FIXATION

The manner in which roof tiles are installed makes them a highly effective water shedding assembly that affords years of service and protection. The effectiveness of a tile roof system as a weather resistant assembly however depends on the proper installation of all the tile roof components, and installing them properly is critical to the performance of the installed system.

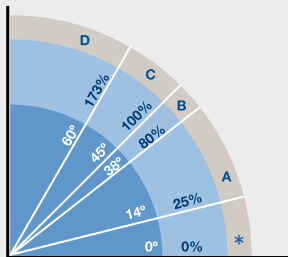

D: Every tile should be securely fastened (Nailed, screwed, clipped...) (60° / 203/4:12).

C: As a minimum, each tile in every five proportion, should be secured with (10 gauge) non-corrosive ring shank nails or screws (45° / 12:12).

B: Each tile hangs on the batten (held by the nib) (38° / 10:12).

A: Each tile hangs on the batten, held by the nib. When mortar is used, back bed and face point with color matched mortar. Clean off all excess mortar from the face of the tiles. For Foam Adhesive, refer to local building codes.

* La Escandella recommended minimum slope requirements is 30% (4:12).

VENTILATION

Ventilation is one of key elements to assure a good hygrothermal behavior of the roof and preservation of the roof structure. The key to a good and well preserved roof is a good ventilated roof. Proper installation of Ventilation tiles combined with ventilated roof can result in energy savings, in a more energy efficient home.

Air should be able to flow through the eave and ridge; be sure not to close these off with cement, mortar or similar. Eave and ridge areas should be protected to help minimize the access of birds and vermin infiltration.

A free flowing ventilation area must be provided through the roof deck. This ventilation should be evenly distributed throughout the roof space to eliminate any dead air space.

La Escandella recommends a minimum of 1 Innova ventilation tile (Q117K) for every 7 m² (1.32 vent tiles per 100 sq ft.) and with a minimum of 2 ventilation tiles per roof surface, installed on the upper part of the roof.

Using a proper ventilation system is the best way to avoid moisture in a roof, that could cause peeling, cracking and other defects on the tile.

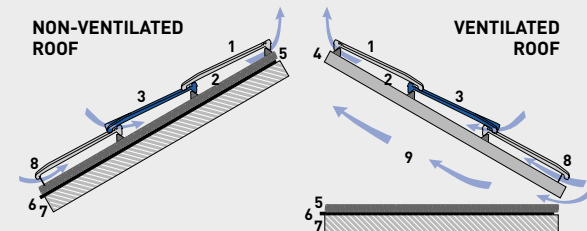

1. Roof tile
2. Micro-ventilation void
3. Ventilation roof tile
4. Rafter
5. Heat insulation underlayment
6. Waterproof underlayment material
7. Frame
8. Eaves ventilation comb / bird stop
9. Attic



SELECTION

La Escandella



www.laescandella.com



Colour Shall be Harmonized but clay tiles are a natural product and some shade variations between individual pieces enhance their beauty and should be expected. All Tiles should be blended regardless of the number of colours supplied. Colours of the tiles shown in this catalogue can not faithfully reflect the colours of the ceramic tiles.

On their products, La Escandella has right to make changes in dimensions, fittings, weight & units per pallet, without previous notice. For more information, please contact your Sales Representative or our Customer Service.

This catalogue, printed in January 2018, replaces the existing ones.